



CMF5U

Pre-programmed, configurable controller for simple applications

CMF is a series of pre-programmed, configurable controllers intended for DIN-mounting that can be set to handle everything from temperature or humidity control to CO₂ and pressure control. Features also include a general control usable for several different control modes.

- Language independent
- Simple configuration via the backlit display
- Input for external setpoint device

CMF5U is a pre-programmed, configurable controller for air handling or pressure control applications.

CMF

CMF is a series of controllers intended for control of temperature, CO₂, pressure, air handling, and heating applications. A stand-alone controller for smaller applications, the controller is very easy to install, set-up and control.

CMF uses a display with an encoder knob, making its built-in menu system very easy to use. Settings are entered by turning the encoder knob to a desired parameter/value. A value is then approved by pressing the knob.

Models

The CMF series comprises two different models, the CMF5U and the CMF10 SPI. CMF5U has 6 in-/outputs and CMF10 has 11 in-/outputs. CMF5U is intended for 24 V AC supply voltage. CMF10 is available in versions for both 24 V AC and 230 V AC.

Easy to install

CMF is suitable for DIN-rail or cabinet mounting. Since the terminals are detachable, all connections can be made before CMF is installed.

- Pre-loaded with several application modes
- Simple handling using push-/turn knob
- Temperature sensor input can be set to three different ranges

CMF5U applications

CMF5U is preprogrammed with a choice of five different control modes:

- Three temperature measurement ranges, see page 3
- CO₂ control
- General control, such as for humidity
- Pressure control
- Outdoor temperature compensated pressure control

Inputs and outputs

CMF5U has:

- Three temperature measurement ranges, see page 3
- 1 analogue input, PT1000
- 1 SPI input for an external setpoint device
- 1 universal input, 0...10 V DC or digital
- 1 digital input
- 2 analogue outputs, 0...10 V DC

External setpoint device

When the -20...+60 measurement range is in use, an external model SAP-PT1000-1 unit can be used. The setpoint for this can be set between 5...30°C.

CMF has been developed in accordance to our Ready-Steady-Go concept, simplifying every step from installation to management.

Display and encoder knob

All setting and configuration is performed using the display and encoder knob on the front of the controller.

The menu information shown on the display is organised in a tree fashion. By using the knob, you can move in between menus, set values etc.

In any of the configuration menus, pressing the encoder knob will activate change mode. You can then turn the knob to move between choices or set values. A second press of the knob will accept the choice.

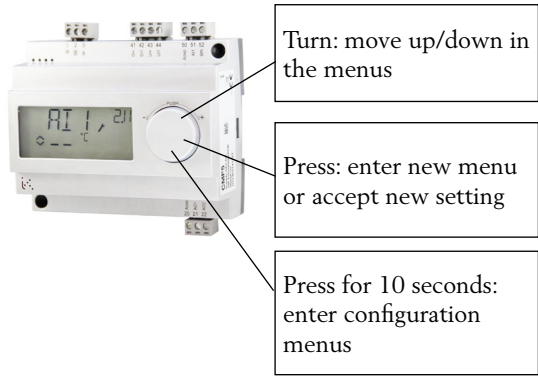

The menu system is divided into two levels:

- Base level - view mode
- 10-second level - configuration area

Base Display

This is an example of the Base Display. It is normally shown when there is no operator activity.

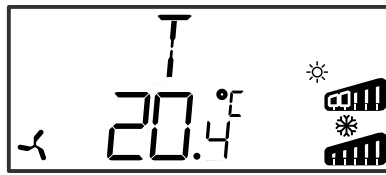

The upper row shows which control mode has been configured, in this case control mode 1, Temperature control, and the bottom row shows the actual value. The bar-graphs show the current output levels. In control mode 1, there are symbols showing how the outputs have been configured (Heating, Cooling, Damper or Change-over).

When the base display is shown (by turning the knob counter-clockwise until the text I/O is displayed and then pressing it), you can gain access to a menu where you can examine the values and states of all inputs and outputs.

To exit this menu again, click on the knob and then turn it clockwise. You will then be returned to the Base Display.

Display information

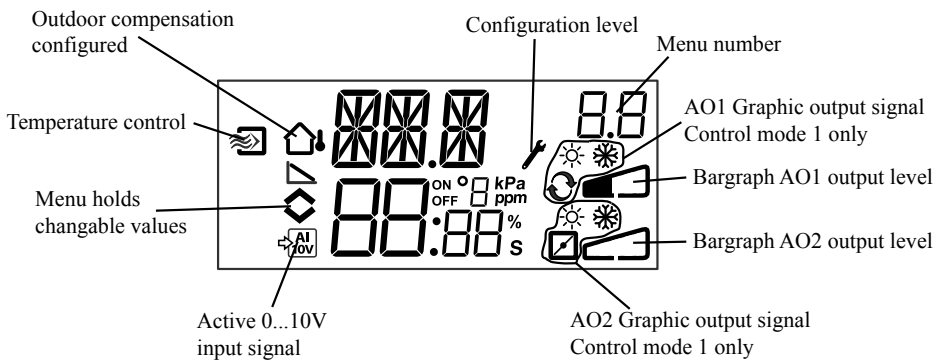

Configuration

All the configuration menus lie in the 10-seconds level. This level is accessed from the Base Display by pressing and holding the encoder knob for 10 seconds.

There are numerous configuration menus covering all available options and combinations.

In some cases, making a certain choice in one menu will mean that you will only see certain other menus. For example, the menu for setting the damper minimum limit is only shown if you have configured AO2 to be a damper control output.

Application examples

CMF5U can be configured to any one of the following control modes.

Three selectable temperature ranges: -20...+60°C, 20...100°C, 60...140°C

The temperature at the sensor is kept at the setpoint value by controlling the output signals on AO1 and AO2. The setpoint can be set directly in the display or via an external setpoint device. A single PI control loop is used.

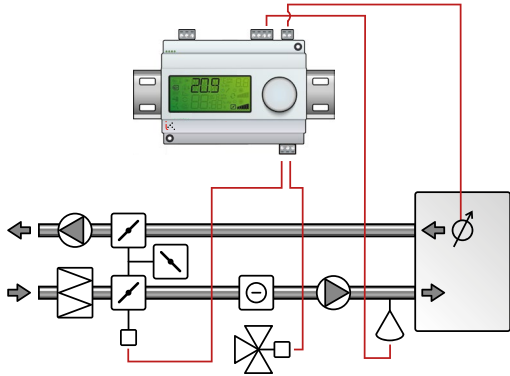

The analog outputs can be configured in accordance with the following combinations:

AO1	AO2
1. Heating	-
2. Cooling	-
3. Heating	Cooling
4. Heating	Heating
5. Cooling	Cooling
6. Heating	Damper
7. Cooling	Damper
8. Change-over*	-

* (Seasonal change-over between heating and cooling)

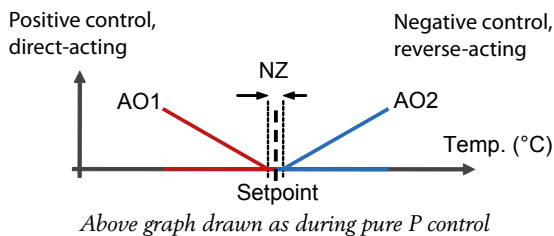

CO₂-control

The CO₂ value at the sensor is kept at the setpoint value by controlling the output signal on AO1. A single PI control loop is used. Min-/max limitation of the output is possible.

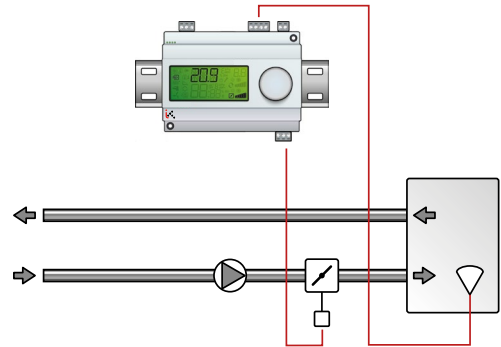

The output signal will increase when the CO₂ value rises above the setpoint value.

The CO₂-sensor must have a 0...10 V DC output.

Use one of the below Regin brand sensors:

- TCO2A, TCO2A-D Room sensors
- TCOC1111 Duct sensor

The sensor's transmitter range may not exceed 9900 ppm at 10 V DC output.

General control

The actual value at the sensor is kept at the setpoint value by control of the output signals on AO1 and AO2. AO1 is used for positive control, AO2 for negative control. A single PI control loop is used.

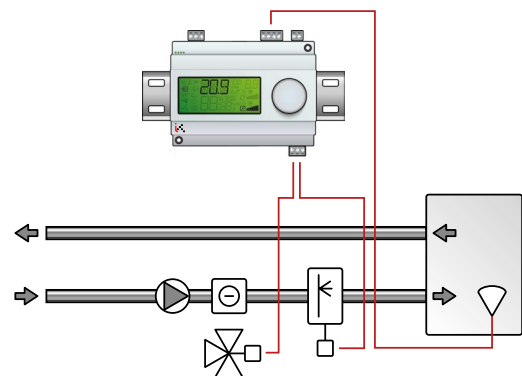

AO1 and AO2 are controlled in sequence. A neutral zone for the controller can be set between AO1 and AO2. The actual value must be provided by a transmitter with an output signal of 0...10V DC. This control mode can for instance be used for humidity control. If so, use one of the below AB Industrietechnik's sensors:

- TUA or TTUA Room humidity transmitters
- TUC1 Duct transmitters

Pressure control

The pressure at the sensor is kept at the setpoint value by controlling the output signal on AO1. A single PI control loop is used. The AO1 inverted signal is provided via AO2. Normally, either AO1 or AO2 is used.

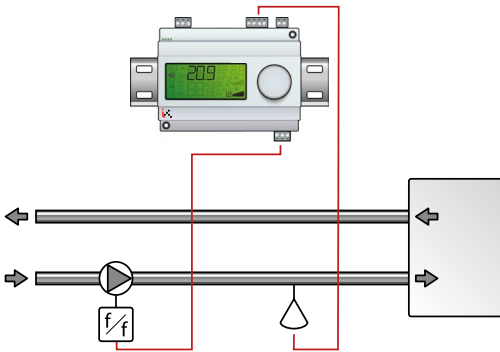

The AO1 output signal will increase when the pressure signal falls below the setpoint value.

The pressure transmitter must have an output signal of 0...10V DC. Use one of the below AB Industrietechnik's sensors:

TPDA
TPDL series
TPL series

Pressure ranges of up to 2500 kPa can be set.

Pressure control with outdoor compensation

The pressure at the sensor is kept at the setpoint value by controlling the output signal on AO1. The setpoint is automatically adjusted according to the outdoor temperature. A single PI control loop is used. The AO1 inverted signal is provided via AO2. Normally, either AO1 or AO2 is used.

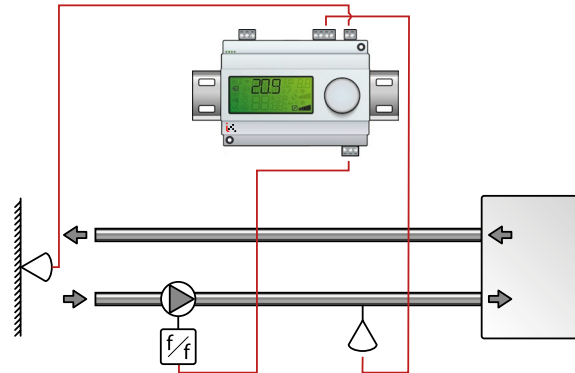

The output signal will increase when the pressure signal falls below the setpoint value.

The setpoint value follows a settable pressure-to-outdoor temperature relation.

When using this control mode, the temperature range is set to the low range, i.e. -20...+60°C.

The pressure transmitter must have an output signal of 0...10 V DC. Use one of the below AB Industrietechnik's sensors:

TPDA
TPDL series
TPL series

Pressure ranges of up to 2500 kPa can be set.

Technical data

Supply voltage	24 V AC; $\pm 15\%$, 50...60 Hz
Internal consumption	4 VA
Ambient temperature	0...50°C
Storage temperature	-20...70°C
Ambient humidity	Max 90% RH
Display	Numerical/graphic w. background illumination
Protection class	IP20
Material, casing	Polycarbonate, PC
Terminal blocks	Disconnectable, lift type for cable cross-section 2.5 mm ²
Weight	215 g
Colour	Cover: White Bottom part: Dark gray



Low Voltage Directive (LVD) standards: OP10-230 conforms to the requirements of the European Low Voltage Directive (LVD) 2006/95/EC through product standard 60730-1 and EN 60730-2-9.

EMC emissions & immunity standards: This product conforms to the requirements of the EMC Directive 2004/108/EC through standards EN 61000-6-1 and EN 61000-6-3.

RoHS: This product conforms to the Directive 2011/65/EU of the European Parliament and of the Council.

Inputs

Analog inputs	Two
AI1	PT1000 sensor, accuracy $\pm 0.5^\circ\text{C}$
SPI	PT1000 setpoint device, measuring range 0...40°C, accuracy $\pm 0.5^\circ\text{C}$
Universal input	One analog or digital input
AI	0...10 V DC, accuracy $\pm 0.15\%$ of full output
or DI	Closing potential-free contact
Digital input	One
DI	Closing potential-free contact

Outputs

Analog outputs	Two
AO	0...10 V DC; 8 bit D/A short-circuit protected

Settings

Setpoints

Temperature setpoints

Temperature ranges	-20...+60, +20...+100, +60...+140°C
Via external setpoint device	+5...+30°C (SAP-PT1000-1)
Neutral zone	0...10°C
P-band	0...99°C
I-time	0...990 sec.
Min.-limit damper	0...99 %
Setpoints	-18...+60, 22...100, 62...140°C, via external 5...30°C

Other settings

Setpoints	0...9900ppm
CO ₂	(The settable range corresponds to the sensor measuring range)
General (GEN)	0...100% (The settable range corresponds to the sensor measuring range)
Pressure (Pa)	0...2500 kPa (The settable range corresponds to the sensor measuring range)
UI1 scaling	0...10VDC in
CO2	10...9900ppm
General	1...100%
Pressure	100pa...2500kPa
Neutral zone	12.5% of max
P band	
CO2	0...100% of UI1
General (GEN)	0...100% of UI1
Pressure (Pa)	0...300% of UI1
I time	0...990s

Control mode 5

Start point for outdoor compensation	-20...+60°C
Setpoint pressure at -20°C outdoor temp.	0...2500kPa

Wiring

CMF5U

Terminal	Designation	Operation
1	G	24 V AC
2	G0	
3	⏏	

Terminal	Designation	Operation
20	A _{GND}	Reference for AO1 and AO2
21	AO1	0...10 V DC output
22	AO2	0...10 V DC output
41	DI+	Reference for DI1
42	DI1	Digital input
43	UI+	Reference for UI1 digital mode
44	UI1	Universal 0...10 V DC or digital input
50	A _{GND}	Reference for AI1, SPI, UI1 as analog input
51	AI1	PT1000 temperature sensor input
52	SPI	Input PT1000 setpoint device

Dimensions

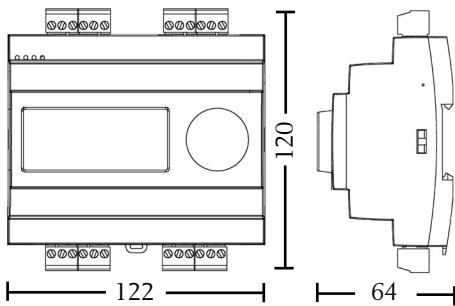

(mm)

Product documentation

Document	Type
Manual	Manual CMF5U
Instruction	Instruction CMF5U

AB Industrietechnik Srl

Via Julius Durst, 70 - 39042 Bressanone (BZ) - Italy

Tel. +39 0472/830626 - Fax +39 0472/831840

E-mail: info@industrietechnik.it

Homepage: www.industrietechnik.it